

Features

1. Explosion-proof product
2. Using a frosted PC cover, the light is uniform;
3. Adopted 2835 LED;
4. Various specifications are available and support customization;

Application

Suitable for gas station cornices, mines and other places. And projects that require products to have explosion-proof certification;

Installation

Fixed by clips

Intrinsically safe parameters and max internal equivalent parameters

Model No.	FB-R-05028 / FB-R-10056 / FB-R-14084 / FB-R-27161
Max input voltage (Ui)	24V
Max input current (Ii)	---
Max internal equivalent parameter	Ci(μF)≈0 / Li(mH)≈0

Specification

Model No.	Light Color	Color Temperature (nm/K)	Beam Angle	Typical Luminous Flux value(lm/pcs)	Ra	Efficacy (lm/W)	Voltage (V DC)	Power (W/pcs)
FB-R-05028	R	620-625	180°	73	/	19	24	3.84
FB-R-10056				146				7.68
FB-R-14084				204				10.75
FB-R-27161				394				20.74

Photoelectric parameters without cover

Model No.	Light Color	Color Temperature (nm/K)	Beam Angle	Typical Luminous Flux value(lm/pcs)	Ra	Efficacy (lm/W)	Voltage (V DC)	Power (W/pcs)
FB-R-05028	R	620-625	120°	134	/	35	24	3.84
FB-R-10056				269				7.68
FB-R-14084				376				10.75
FB-R-27161				725				20.74

Other Parameters

Model No.	LED Quantity/pc	Product Size L*W*H(mm)	Standard Run(pcs)	Max Run(pcs)	Working Temperature	Storage Temperature
FB-R-05028	28	500*30*42	1	12	-20~+50°C	-20~+70°C
FB-R-10056	56	1000*30*42		6		
FB-R-14084	84	1400*30*42		4		
FB-R-27161	161	2700*30*42		2		

NOTE:

1. Testing temperature: 25±2°C
2. The above data are typical values. The actual data of each single product may differ from the typical values. The data is subject to change without notice.
3. Luminous flux is tested when lighting on single color.
4. Lamp beads in different gears, the color temperature and luminous flux will be different.
5. Luminous flux, power and current tolerance within ±10%.
6. Max run is in double feed.

Profile Drawings

Unit:mm[inch]

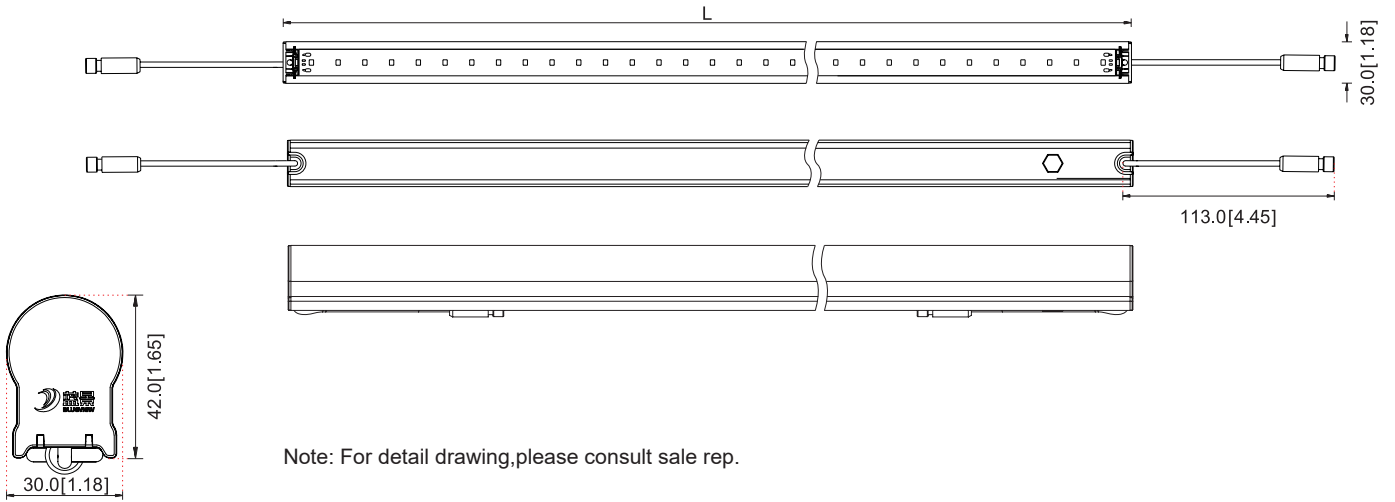

Luminous Intensity Distribution Diagram

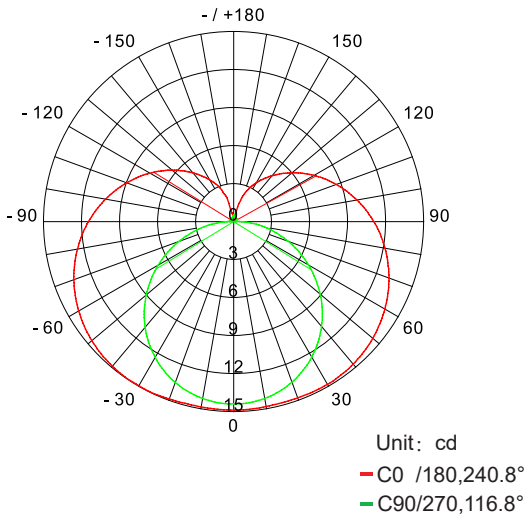

AVERAGE BEAM ANGLE(50%): 178.8°

Average Illumination

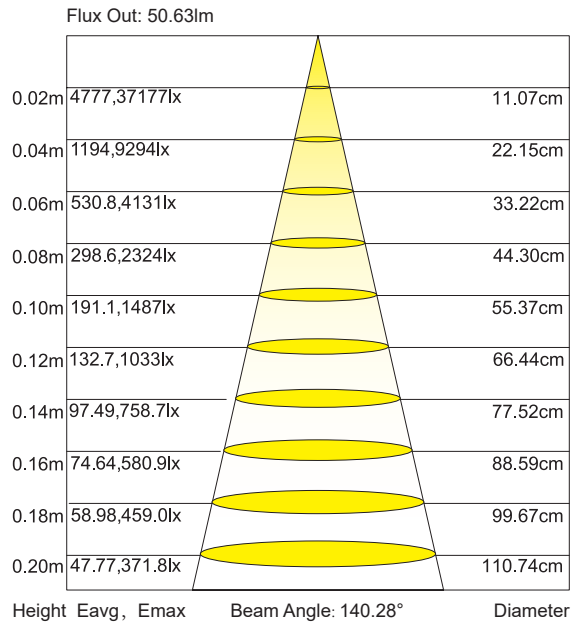

Note:the above data tested with the sample FB-R-05028(with cover). For other data,please consult sale rep.

packing

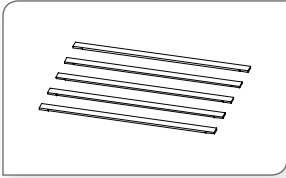

Put products on the table;

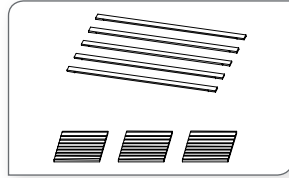

Use 2 blister trays below 1m;
use 3 blister trays above 1m;

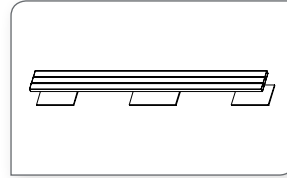

Put products into blister trays;

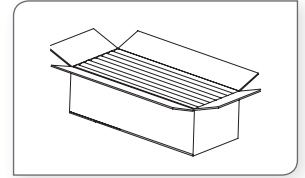

Put the products neatly into carton box.

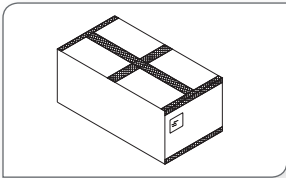

Seal and label the box.

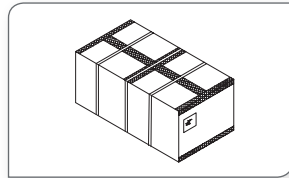

Use packing belt to pack and edge protectors are needed.

Packaging information

Model No.	Product Size L*W*H(mm)	Carton Size(mm)	Clip Quantity(Pcs)	Pcs/Carton Box	Net Weight(kg)	Gross Weight(kg)
FB-R-05028	500*30*42	1030*315*180	2	40	9.20(1±10%)	11.30(1±10%)
FB-R-10056	1000*30*42	1030*315*180	3	20	8.60(1±10%)	10.50(1±10%)
FB-R-14084	1400*30*42	1420*315*180	4	20	12.00(1±10%)	13.50(1±10%)
FB-R-27161	2700*30*42	2740*315*135	8	15	17.50(1±10%)	19.00(1±10%)

Note:

1. Packing material:blister trays and carton box
2. The above quantity and weight are only for the illustrated packaging method. There will be differences in the quantity and weight with other packaging methods.

Installation

Connection Diagram

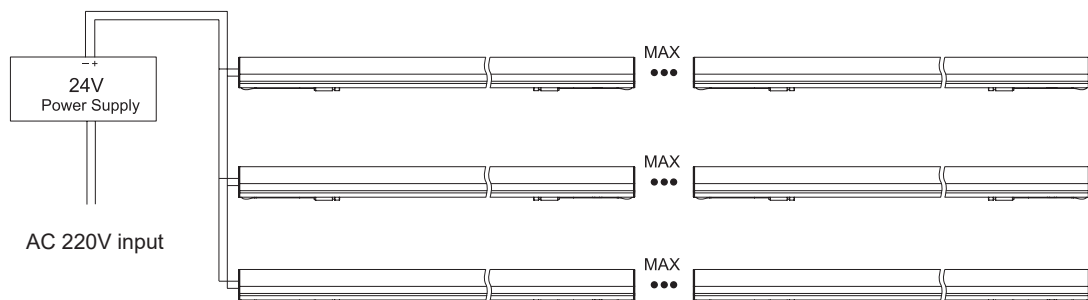

Note:the "MAX" here means the max run quantity.

3.Products and Tools

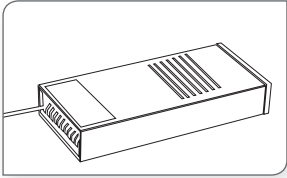

LED power supply

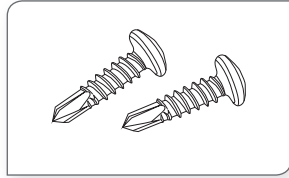

Self-tapping screw

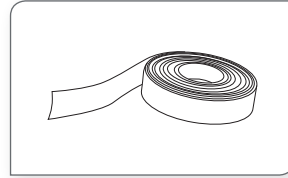

Insulation Tape

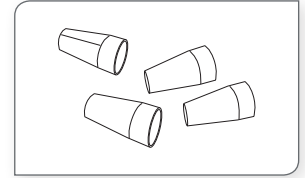

Connection terminal

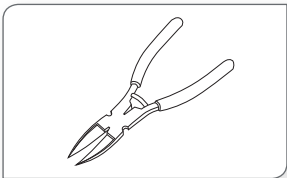

Diagonal pliers

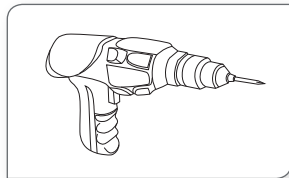

Electric drill

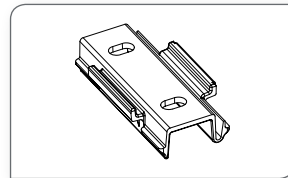

Mounting clip



Attentions before installation

- Before installation, check that the product parameters are consistent with the requirements (Seeing product specifications or product labels)
- Load voltage, current, power and power supply should be matched with the product.
- Follow the instructions of wiring diagram (first connect the load and then the power supply) to avoid short circuit.
- Make sure the correct connection of positive and negative poles between products and power supply. Otherwise, the light will not be on.
- Make sure the power cord firmly screwed into the terminal and it should not be pulled out by hands.
- The terminal should have insulation, waterproof and anti-corrosive treatment.
- This product should be installed out of arm's reach.

Common Faults and Troubleshoot

Quick Guide		
Problems	Reasons	Solutions
All LEDs can not light on.	No electric supply.	Fix the short circuit problem.
	Automatic power protection from the open or short circuit in output of the power supply.	
	Wrong connection of power supply.	
LEDs can not light on partly.	Some switching mode power supplies are not powered.	Correctly connection.
	Power supply line error.	
	Mistaken wire connection of some of products	
Brightness of LED is inconsistent tor insufficient.	Power overloaded.	Replace with more powerful power.
	Power supply circuit excessive consumption.	Make sure the working voltage of the product within $\pm 5\%$ of standard voltage, or keep balance by circuit power consumption.
	Excessive quantities in series connection of the product	Reduce the quantities of the product in series connection to meet requirement.
LED flicker.	Connection point fault.	Remove bad connection point.
	Switching power supply failure.	Replace a new power supply.
	Wrong Installation or use of products	Please follow the instructions

Warning

- Do not disassemble or retrofit the light. Do not touch the surface of the light with a sharp object.
- Do not do live-line working during installation, especially for high voltage product.
- Do not use any organic chemical solvents.
- Use neutral glass adhesive to fix this product and it needs to be dried 24 hours in the open environment after operation.
- Treat the ends and the circuit connection points that are not connected to the main line with insulation, waterproof, and anti-corrosion in the installation.
- Use 18AWG (0.75mm² cross-sectional area) or thicker core wire to avoid adverse consequences caused by overheating, if the power cable need to lengthen.
- Make sure the input voltage meets the requirements and lines are connected correctly before lighting on.
- This product is for signage, and do not use as general lighting.
- Series connection within the max run.
- The length of the power cable between the power supply and the led strip should not exceed 2 meters. Otherwise, large circuit loss will lead to inconsistent brightness.
- Installation, maintenance and repair should be operated by a qualified technician.
- The light source of this luminaire is not replaceable; when the light source reaches its end of life the whole luminaire shall be replaced.
- The usage quantity can not exceed the standard run.

Statements and Recycling

Statements:

- Repair should be operated by a qualified technician, if the external circuit or main line of this product is damaged.
- The parameters given in this manual are typical values and for reference only.
- All illustrations and drawings in this manual are for reference.
- This product is subject to change without notice.

Recycling:

- LED lighting products belongs to electronic products, please do recycling treatment according to the relevant WEEE directives.